

# BLUETOOTH KEYLESS ACCESS



# TL

**TURBOLOCK™**

## TL-99

In order to continue serving our customers and providing the best products, our product information including our user manuals may receive updates from time to time. Please check our website for the latest user manuals and product materials.

## User Manual

v2. 063017

***TURBOLOCK™***

[www.turbolock.com](http://www.turbolock.com)

Customer Service: 855-850-8031

# Table of Contents

<b>Section 1</b>		<b>Section 5</b>		<b>Section 10</b>	
<b>Information &amp; Safety Warnings</b>	<b>4</b>	<b>Using the Admin Password</b>	<b>11</b>	<b>Maintenance</b>	<b>15</b>
1.1 Introduction	4	5.1 Information	11		
1.2 Safety Warnings	4	5.2 Changing the Admin Password	11	<b>Section 12</b>	
1.3 Disposal at End-of-Life	5			<b>Troubleshooting</b>	<b>16</b>
<b>Section 2</b>		<b>Section 6</b>		<b>Section 13</b>	
<b>Package Contents &amp; Overview</b>	<b>6</b>	<b>Using Passive Function</b>	<b>12</b>	<b>Warranty</b>	<b>18</b>
2.1 Contents	6	Turning on the Passive Function	12	13.1 Violation	18
2.2 Overview	6	Turning off the Passive Function	12	13.2 Information	18
<b>Section 3</b>		<b>Section 7</b>			
<b>Installation</b>	<b>7</b>	<b>Using the Mute Function</b>	<b>12</b>		
3.1 Step by Step	7	Muting	13		
3.2 Battery Information	10	Un-muting	13		
<b>Section 4</b>		<b>Section 8</b>			
<b>How to Use the TurboLock</b>	<b>10</b>	<b>The TurboLock App</b>	<b>13</b>		
Using the Admin Password	10	8.1 Installation	13		
Using the Emergency Power Jack	10	8.2 Pairing	14		
Using a User Password	10	<b>Section 9</b>			
Passive Function	11	<b>Resetting the Lock</b>	<b>15</b>		

## Information & Safety Warnings

### 1.1 Introduction



This user manual will guide you through the functions and usage of your TurboLock TL-99 Bluetooth-enabled Smartlock. It is important that you follow all instructions and regard all notes that appear throughout this manual. Consult this manual before you attempt to use your lock. If you have questions not answered by this manual or are in need of repair or non-routine service, contact customer service at 1-855-850-8031. Before contacting customer service, please have your purchase information ready as this may be needed during the call. This information may be recorded below.

**Date of Purchase:**

**Place of Purchase:**

### 1.2 Safety Warnings

When reading this manual, note these icons:

-  Notes with this icon **MUST** be read, understood, and obeyed to prevent injury or damage etc.
-  Notes with this icon include relevant information.

#### **Overall Usage**

- The lock shall only be used as described in this manual.
- Verify that all parts of the lock are accounted for. If any part is missing, contact customer service.
- If the battery compartment or surrounding parts are damaged, do not use the lock.
- Use only four alkaline AAA batteries. Do not mix old and new batteries or batteries from different brands.
- Never insert objects into the lock other than batteries as described in this manual.

- The lock is not a toy. Do not leave children unsupervised around the lock.
- Use only the parts included in the original packaging or received from TurboLock.
- Verify all surfaces are flat and level before beginning installation. Installation on doors or surfaces with any type of deformity such as gaps or warping may cause the lock to malfunction or fail to operate entirely.
- Expected use is for standard doors made for buildings within the US.
- Generally, the batteries may offer up to one full year of use before replacement is needed. Battery life varies by usage.
- Replace the batteries after receiving the lock's low battery notification.
- Never apply any cleaner directly to any part of the lock. Only use clean water, mild cleaner, and soft, non-abrasive cloth when cleaning.
- Risk of shock. Do not allow water and/or liquids to get into the lock's electric parts.
- Never submerge the lock or any of the lock's components.
- Hanging objects on the lock is not recommended.
- The lock may be used with the TurboLock app. The lock will function without the app but full functionality may only be achieved when the app is used.

### **1.3 Disposal at End-of-Life**

This product must not be disposed of by incineration, landfilling, or mixing with household trash. Improper disposal of the battery contained within this product may result in the battery heating up, rupturing, or igniting which may cause serious injury. The substances contained inside the battery present chemical risks to the environment. The recommended disposal for any TurboLock TL-99 at its end-of-life is to dispose of the entire unit at or through an e-waste recycling center, program, or facility. Local regulations and laws pertaining to the recycling and disposal of lithium ion batteries and/or products containing them will vary according to country, state, and local governments. You must check laws and regulations corresponding to where you live in order to properly dispose of the battery and/or unit. It is the user's responsibility to dispose of their waste equipment properly with accordance with local regulations and laws.

For additional information about where you should drop off your batteries and electrical or electronic waste, please contact your local or regional waste-management office, your household waste disposal service, or your point-of-sale.

## Package Contents & Overview

### 2.1 Contents

TL-99 Bluetooth-enabled Smartlock x 1

Latch Assembly x 1

Screw Pack x 1

Backup Battery Pack x 1

(N) Batteries not included.

### 2.2 Overview

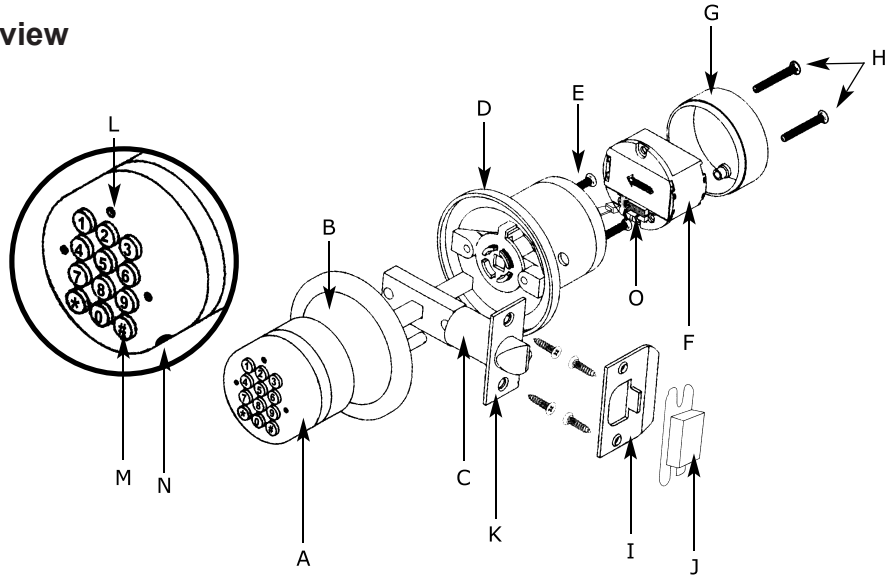

A: Outside Knob  
B: Outside Rose Plate  
C: Latch Assembly  
D: Inside Rose Plate  
E: Mounting Screws

F: Battery Box  
G: Inside Knob Cover  
H: Cover Plate Screws  
I: Strike Plate  
J: Wrought Box

K: Latch Faceplate  
L: LED Indicator  
M: Keypad  
N: Emergency Power Jack  
O: Reset Key

## Installation

### 3.1 Step by Step

- Ⓝ • The following installation instructions were made in reference to a door which did not already have a handle opening. If switching out an existing handle, it may be possible to skip some steps.
  - For ease of installation, it is recommended to perform installation with the assistance of another person.
  - After finishing installation, be sure to use the door at least once to make sure all parts of the lock function correctly.
- ⚠ KEEP DOOR AJAR at all times during, before, and shortly after installation. If the lock is incomplete or improperly installed, and the door is then closed, the lock and/or door may become stuck.

#### Step 1. Marking the Door

Using the template, mark a hole on both sides of the door at required backset, then mark the latch hole on door edge.

#### Step 2. Drilling Holes

Bore a 2 in. hole on door face, then drill a 1 in. hole in the door edge to intersect with center of 2 in. hole.

- Ⓝ Drill a 2 in. hole from both sides of door to stop wood splintering.

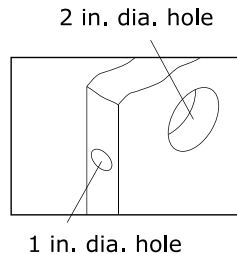
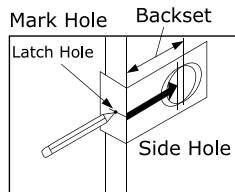

### Step 3. Installing the Latch

- Insert the latch into the hole, mark a line around edge of latch plate to use as a guide, and remove latch. (Fig. 3a)
- Chisel approx. 0.1 in. deep or until latch plate sits flush with door edge. (Fig. 3b)
- Insert the latch drill 2 x 0.1 in. holes for mounting screws and fasten latch. (Fig. 3c)

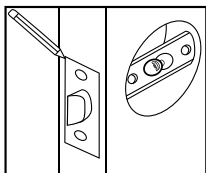

(Fig 3a)

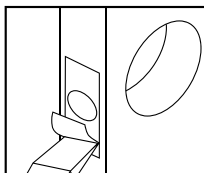

(Fig 3b)

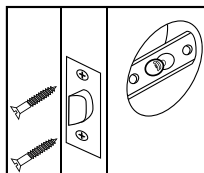

(Fig 3c)

### Step 4. Installing the Strike

- Close door and mark the horizontal center of the latch on the door frame. Mark the vertical line where the door edge meets the frame and measure in half of the door's thickness to find the vertical center. (Fig. 4a)
- Extend both lines until they intersect and drill a 1 in. hole to 0.1 in. depth.
- Position the strike plate and mark around the edge.
- Chisel the frame to approx. 0.1 in. depth or until the strike sits flush.
- Drill 2 x 0.1 in. screw holes and fix the strike to the frame. (Fig. 4b)

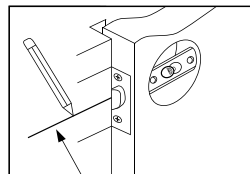

(Fig 4a)

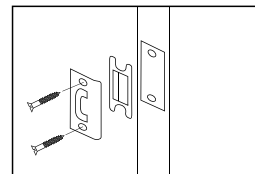

(Fig 4b)



**Step 5. Install Outside Knob** (Fig. 5)

- Feed the power cable through latch and guide spindle through until outside rose sits flush.

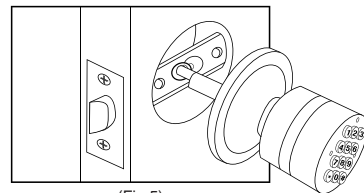

(Fig 5)

**Step 6. Install Inside Knob**

- Feed power cable through hole in knob and guide spindle into handle. (Fig. 6a)
- Screw inside knob to outside knob using mounting screws. (Fig. 6b)

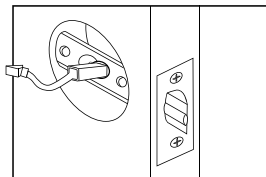

(Fig 6a)

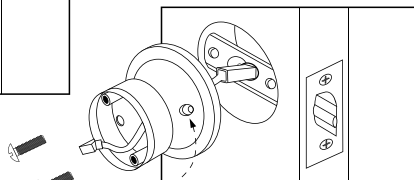

(Fig 6b)

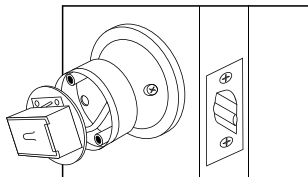

(Fig 7)

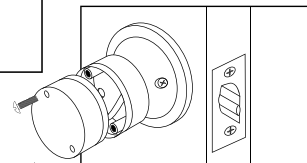

(Fig 8)

**Step 7. Plug in Battery Box** (Fig. 7)

- Insert power cable into battery box and position box in line with cover screw holes

**Step 8. Install Inside Cover Plate** (Fig. 8)

- Position cover plate over battery box and align with screw holes.
- Fasten screws to secure cover plate to inside knob.

### **3.2 Battery Information**

The lock requires four standard or rechargeable alkaline 'AAA' batteries which will be stored inside the back of the lock. New batteries should be installed as soon as possible after receiving any low battery indication. When the notification begins, the lock will only have enough power for approximately 50 times before the batteries are fully depleted. This indication can be received from the app or the lock itself; the lock will beep after being unlocked. Expected battery life is approximately 365 days. If needed, use the included Backup Battery Pack with the lock's Emergency Power Jack.

#### **Section 4**

## **How to Use the TurboLock**

The TL-99 provides a variety of ways to open your door. Each time the lock engages and unlocks the door, regardless of entry method, the door can only be opened while the backlight is still on and the lock is beeping. After it stops, the lock will automatically engage again and lock the door.

### **Using the Admin Password**

Touch any key so that the keypad lights up, enter the Admin Password, and then press '#' to unlock the door. Note, the Admin Password must be changed from the manufacturer's default. See Section 5.

### **Using the Emergency Power Jack**

Use the Backup Battery Pack to supply power via the Emergency Power Jack on the bottom of the lock. The backlight will turn on indicating the lock is receiving power. Enter a password and then press '#' to unlock the door as usual.

The remaining unlock methods in this section are available through the TurboLock app. Note, the TurboLock Bluetooth-enabled Smartlock can be used without the app. However, the app is needed to use the lock's full range of features.

### **Using a User Password**

Touch any key so that the keypad lights up, enter the password received from the app's admin, and then press '#' to unlock the door. Note, User Passwords may have restricted access according to the app admin's discretion.

## Passive Function

After turning the function on, touch any key so that the keypad lights up then open the door. No password is needed.

- **(N)** • The TL-99 features a Mute Function. See Section 7.
- If a password has been entered wrong 3x in a row, regardless of the entry method, the lock will go into a 15-minute period of inactivity where it cannot be used. This is a security feature designed to prevent unwanted parties from using the lock.

### Section 5

## Using the Admin Password

### 5.1 Information

- The Admin Password must always be exactly 6 digits long.
- The default Admin Password is '123456'.
- Remember, the door should always be ajar when adding and/or changing passwords.

### 5.2 Changing the Admin Password

For security, it is highly recommended that you change the Admin Password from the manufacturer default.

**Step 1.** Use the keypad to enter the default ('123456') or the current Admin Password then enter '#'.

**Step 2.** Enter '1' then enter '#'.

**Step 3.** Enter the new Admin Password then press '#'.

**Step 4.** Re-enter the new Admin Password then press '#'.

**Step 5.** Wait for the backlight to go out so that the new password successfully saves.

**Step 6.** If desired, test the new password to confirm the modification was successful.

- Ⓝ • The password must be entered while the blue backlight is on. If it goes out, begin again at Step 1.
- The Admin Password can also be changed via the app. For app information, see the Section 8.
- If the Admin Password is lost or forgotten, the lock may be reset. Refer to Section 9.

#### Section 6

## Using Passive Function

With this function active, the TL-99 can be used to open the door without requiring a password.

- ⚠ USE WITH CAUTION. Remember to turn off the function when it is no longer needed. Do not leave this function on for extended periods of time.

### Turning on the Passive Function

**Step 1.** Use the keypad to enter the current Admin Password, then '#'. The lock will engage.

**Step 2.** While the lock is still emitting sound, press '6' then '#'. The function will be turned on.

### Turning off the Passive Function

Press any key to activate the lock then immediately press '6' then '#'. The function will be turned off.

#### Section 7

## Using the Mute Function

- ⚠ USE WITH CAUTION. Remember to turn off the function when it is no longer needed. Do not leave this function on for extended periods of time.

## Muting

**Step 1.** Use the keypad to enter the current Admin Password, then '#'. The lock will engage.

**Step 1.** Press '5' then '#'. The lock will stop emit sound.

## Un-muting

**Step 1.** Use the keypad to enter the current Admin Password, then '#'. The lock will engage.

**Step 2.** Press '5' then '#'. The lock will emit sound to confirm the lock has been unmuted.

### Section 8

## The TurboLock App

For your convenience, there is a TurboLock app that uses Bluetooth technology to interact with the lock. The TurboLock app is compatible with most Android and iOS smartphones and grants full access to all of the lock's features. The app offers features such as additional to unlock your door, decide who and when passwords can be used, keep record of times when the lock is used, set preferences for real-time unlock notifications, and more. To get the app, follow the instructions below.

### 8.1 Installation

**Step 1.** Use your smartphone to search the Play or App Store for the "TurboLock" application.

**Step 2.** Download and install the app according to your operating system.

**Step 3.** Turn on Bluetooth and open the app.

**Step 4.** Register for an account and return to the app.

- ④ • For instructions and/or information on how to use the app, register for an account and refer to the in-app instructions or visit [www.turbolock.com](http://www.turbolock.com).
- In order to use the app with the TL-99, the two must be paired.

## 8.2 Pairing

In order to connect the app and the lock, Pairing Mode must be turned on.

**Step 1.** Use the keypad to enter the current Admin Password, then '#'. The lock will engage.

**Step 2.** Press '2' then '#'. The lock will emit sound and the light will flash to indicate the lock is ready to pair.

- (N)
- Images for illustrative purposes only. Actual images may vary.
  - App content subject to change without notification.

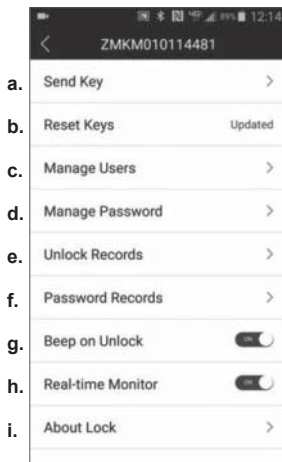

Main Interface (Admin View)



Main Interface (User View)

- a. Send keys to others via email
- b. Touch to reset/erase temporary keypad codes
- c. Touch to view and manage user(s) lock access
- d. Touch to manage admin password or generate temporary access codes
- e. Touch to view unlock records and details
- f. Touch to view temporary access records and details
- g. Toggle the in-app unlock sound on/off
- h. Toggle to turn notifications on/off
- i. Touch to view information about the lock
- j. Toggle the in-app unlock sound on/off
- k. Touch to view information about the lock

## Resetting the Lock

Before resetting the lock, read this section in its entirety to determine if a reset is needed for your individual situation. Resets cannot be reversed.

- ⚠ • Performing a reset may delete passwords including the Admin Password.
- Once all passwords are erased, only the Admin Password can open the lock via the default password.
- After a reset:
  - Admin Password will return to its default '123456'.
  - Choose a new Admin Password immediately. See Section 5.
  - All digital keys and codes issued via the app will be erased. In order to restore app functionality, it must be paired with the lock again.
- A reset should only be used when the Admin Password is lost or forgotten.

### Option 1

**Step 1.** Use the keypad to enter the current Admin Password, then '#'. The lock will engage.

**Step 2.** Press '3' then '#'. The lock will reset.

### Option 2

**Step 1.** Remove the cover from the battery compartment at the back of the lock.

**Step 2.** Find reset button below the battery compartment.

**Step 3.** Press and hold the button for approx. 10-12 seconds until two beeps are heard.

- ⚠ • If the lock is uninstalled or if the internal cables are disconnected and reconnected, it may be reset.
- A reset can also be performed via the app if needed.

## Section 10

# Maintenance

Proper cleaning and maintenance of your lock ensures it will continue to work as it should.

- The keypad is made of acrylic. Use purified water and soft, non-abrasive cloth when cleaning.
- If a mess cannot be cleaned with water, apply a gentle cleaner to the cloth and clean.
- Do not apply any cleaner or detergent directly to any part of the lock.
- After cleaning with any cleaner, rinse with clean water and dry so as not to leave residue on the lock.
- The TL-99 meets IP65 water-resistance, meaning it can withstand splashes and contact with water once properly installed. However, do not submerge the lock.
- Do not let water and liquids get into the lock's electric parts or battery compartment.

## Section 12

# Troubleshooting

Problem	Possible Cause	Solution(s)
Why can't I open the door?	Too much time has passed.	Turn the handle to open the door while the lock's backlight is still on.
	Your access has been restricted.	If you received a key from the lock's admin, your access may be restricted to certain times of the day. Check with your admin regarding these details.



<b>Problem</b>	<b>Possible Cause</b>	<b>Solution(s)</b>
<b>Why does the lock jam? / The door doesn't close.</b>	The latch size is wrong.	Disassemble the lock and check the latch assembly. If retrofitting, compare the latch length and adjust as needed. If installed on a new door, adjust the latch and or, drill into the door to fit the latch as needed.
	The strike plate and latch aren't correctly aligned.	Open the door and check the alignment of both the latch and the strike plate. Adjust as needed.
<b>The lock doesn't work.</b>	The lock isn't receiving power.	Ensure the batteries are properly installed. Remove and reinstall if needed.
	The batteries are entirely dead and/or were not replaced in a timely manner.	Replace the batteries
		Use the micro USB port to power the lock so that the door opens. Replace the batteries.
<b>I entered the password wrong (at least 3x).</b>	If a password has been entered wrong 3x in a row, regardless of the entry method, the lock will go into a 15-minute period of inactivity where it cannot be used. This is a security feature designed to prevent unwanted parties from using the lock.	Wait 15 min. and try again.
<b>Why is does the keypad make double beep sounds?</b>		

Problem	Possible Cause	Solution(s)
I forgot my codes.	The codes were not properly recorded.	Perform a hard reset in order to erase all passwords. In order to perform a hard reset, you must have access to the back of the door. Once a reset is performed, record the passwords in memory or a secure location.

- Ⓝ If none of the above information resolves your issue, please visit our website at [www.turbolock.com](http://www.turbolock.com) or contact customer service at 855-850-8031.

### Section 13

## Warranty

### 13.1 Violation

**The lock cannot be repaired or serviced within its warranty period if any of the following has occurred:**

- The warranty has expired
- Damage occurred during or in relation to non-routine and/or unauthorized disassembly
- Failure to provide a valid proof of purchase when requesting service or repair
- Damage occurred as a result of natural disaster etc.
- Damage occurred due to unexpected factors or man-made reasons (including mis-operation, fluid found in any openings, improper insertion or pulling, hauling, bumping, improper voltage input and others)

### 13.2 Information

One Year Limited Hardware Warranty

Your TurboLock TL-99 Bluetooth-enabled Smartlock (“Product”) includes a One Year Limited Hardware Warranty (“Warranty”). The Warranty covers product defects in materials and workmanship under normal use. This Warranty is limited to residents of the United States and Canada only and is available only to original purchasers. This Warranty gives you specific legal rights and you may also have other rights which vary from state to state.

This Warranty starts on the date of your purchase and lasts for one year (the “**Warranty Period**”). The Warranty Period is not extended if the Product is repaired or replaced. We may change the availability of this limited warranty at our discretion, but any changes will not be retroactive.

Warranty services are provided by Warranty Pro (“WP”). If a hardware defect arises and a valid claim is received within the Warranty Period, at its option and to the extent permitted by law, WP will: (1) repair the hardware defect by using new or refurbished parts that are equivalent to new in performance and reliability; or (2) exchange the Product with a product that is new or refurbished which is substantially equivalent to the original product. This Warranty is for one replacement only of like-items and does not cover items out of production if the product is no longer made or stocked. This Warranty is not assignable or transferable. The original purchaser may call the toll-free number at 1-855-850-8031 for service requests.

When a product or part is exchanged, any replacement item becomes your property and the replaced item becomes WP’s property. This warranty only covers technical hardware defectiveness during the warranty period and under normal use conditions. WP does not warrant uninterrupted or error-free operation of this Product.

This Warranty does not cover any damage due to: (a) transportation; (b) storage; (c) improper use; (d) failure to follow the product instructions or to perform any preventive maintenance; (e) modifications; (f) unauthorized repair; (g) normal wear and tear; or (h) external causes such as accidents, abuse, or other actions or events beyond our reasonable control.

**Important:** Do not disassemble the Product. Disassembling the Product will void this Warranty. Only WP or a party expressly authorized by WP should perform service on this Product.

**DISCLAIMER OF WARRANTY:** THE REMEDIES DESCRIBED ABOVE ARE YOUR SOLE AND EXCLUSIVE REMEDIES AND OUR ENTIRE LIABILITY FOR ANY BREACH OF THIS LIMITED WARRANTY. OUR LIABILITY SHALL UNDER NO CIRCUMSTANCES EXCEED THE ACTUAL AMOUNT PAID BY YOU FOR THE DEFECTIVE PRODUCT, NOR SHALL WE UNDER ANY CIRCUMSTANCES BE LIABLE FOR ANY CONSEQUENTIAL, INCIDENTAL, SPECIAL OR PUNITIVE DAMAGES OR LOSSES, WHETHER DIRECT OR INDIRECT.

SOME STATES DO NOT ALLOW THE EXCLUSION OR LIMITATION OF INCIDENTAL OR CONSEQUENTIAL DAMAGES, SO THE ABOVE LIMITATION OR EXCLUSION MAY NOT APPLY TO YOU.

THE DURATION AND REMEDIES OF ALL IMPLIED WARRANTIES, INCLUDING WITHOUT LIMITATION THE WARRANTIES OF MERCHANTABILITY AND FITNESS FOR A PARTICULAR PURPOSE ARE LIMITED TO THE DURATION OF THIS EXPRESS LIMITED WARRANTY.

***TURBOLOCK™***

COPYRIGHT © 2017 TURBOLOCK. ALL RIGHTS RESERVED.